

Spannzange / collet ER32 DIN6499
Spannbereich / clamping range: 2,0 - 20,0

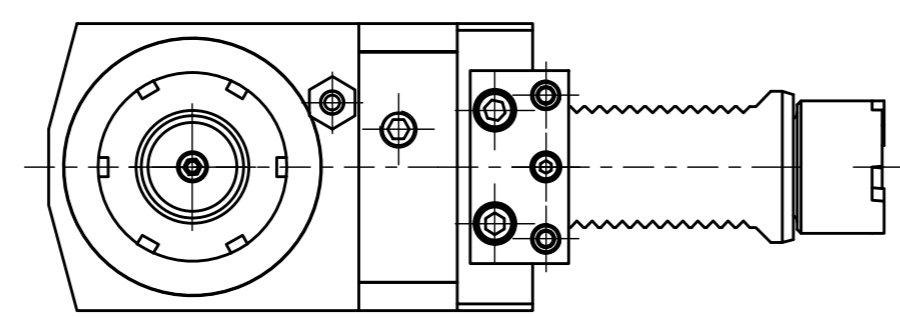

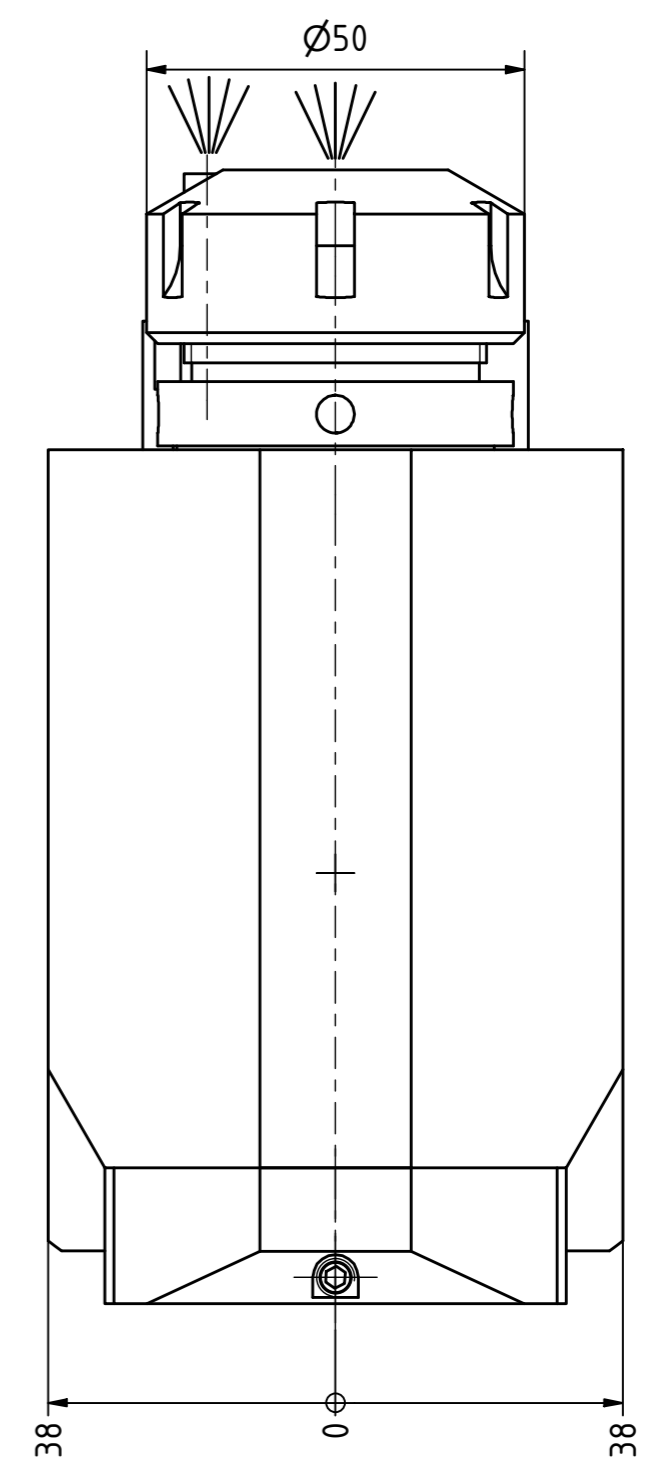

Doppelverzahnung Lizenz Traub
double tooth system licence Traub

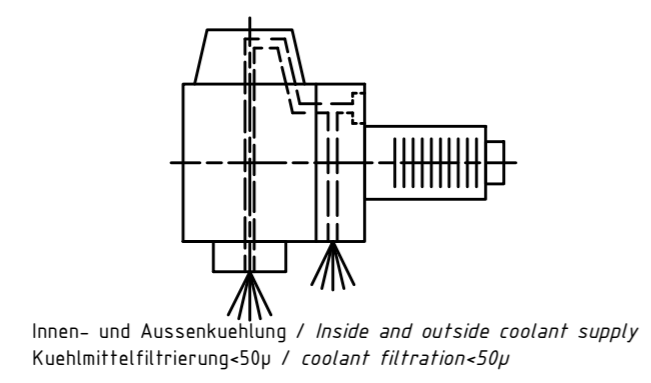

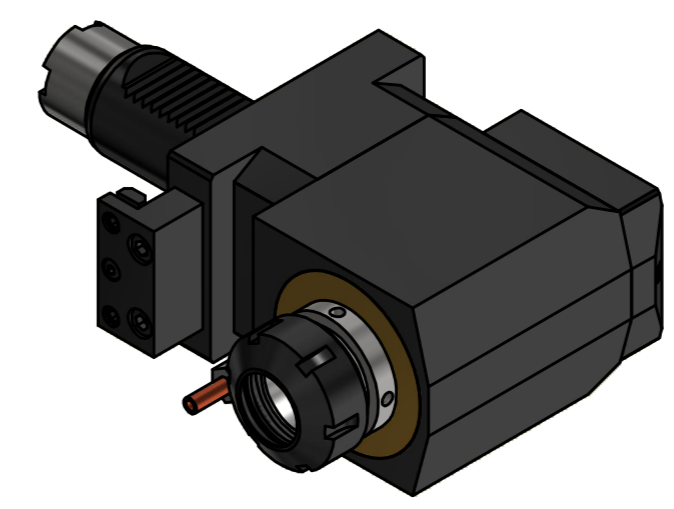
Innen- und Aussenkuehlung / Inside and outside coolant supply
Kuehlmittelfiltrierung=50µ / coolant filtration=50µ

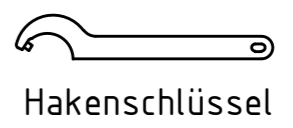

-  Hakenschlüssel mit Zapfen
Hook wrench with fixed pin
DIN1810 B 45x50
-  Spannzangenschlüssel
Clamping wrench
232

Copyright **EWS Tool Technologies**
Weitergabe und Vervielfaeltigung dieser Unterlage, Verwertung und Mitteilung ihres Inhalts nicht gestattet, soweit nicht ausdruecklich zugestanden. Zuwiderhandlungen verpflichten zu Schadenersatz.

<p>Bemerkung - Note Für Trockenlauf geeignet! Use without coolant fluid allowed! mit Kegelrollenlager with taper roller bearing(s)</p>	<p>Technische Daten - technical data Weight = 7.133 [kg] Torque max. (M1/M2) = 40 / 80 [Nm] Speed max. (n1/n2) = 6000 / 3000 [1/min] Gear ratio (i)=n1:n2 = 2:1 Pressure (pmax) = 70 [bar]</p>	<p>Benennung - Title Radial Bohr und Fräskopf Radial drilling and milling head</p>	<p>EWS Tool Technologies EWS Weigle GmbH & Co. KG Maybachstr. 1 D-73066 Ulm/ingen www.ews-tools.de</p> <p>Technische Aenderungen vorbehalten! Subject to technical modifications! IDENT: DEWS151551</p> <p>Nr. - No. 60.4032KRLT25RLIKD12 MNR. 226246</p> <p>REV: -/A</p> 
--	--	--	--