

EWS.Varia

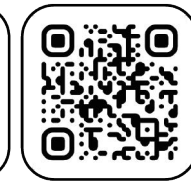

Ceramic Seal



Tech Details

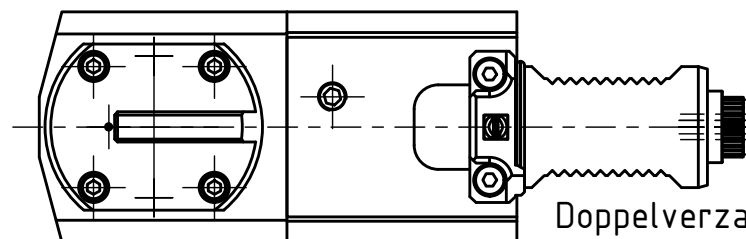
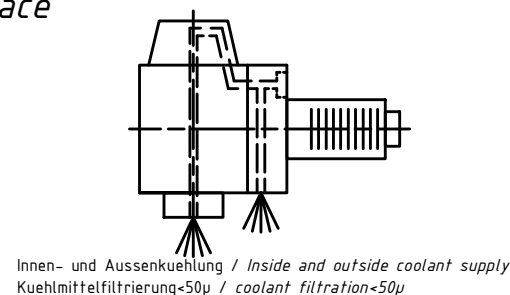
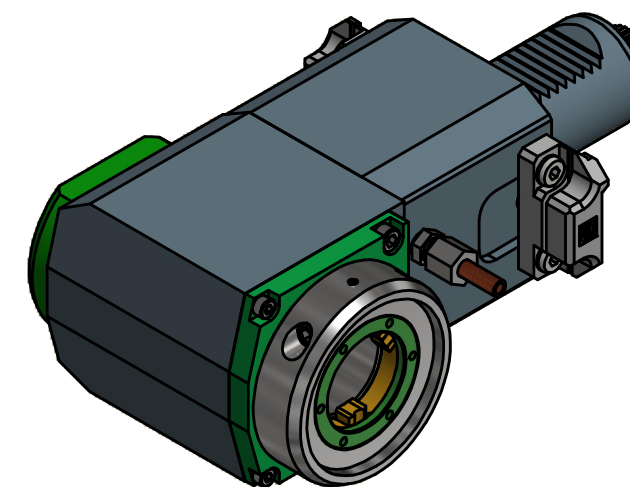
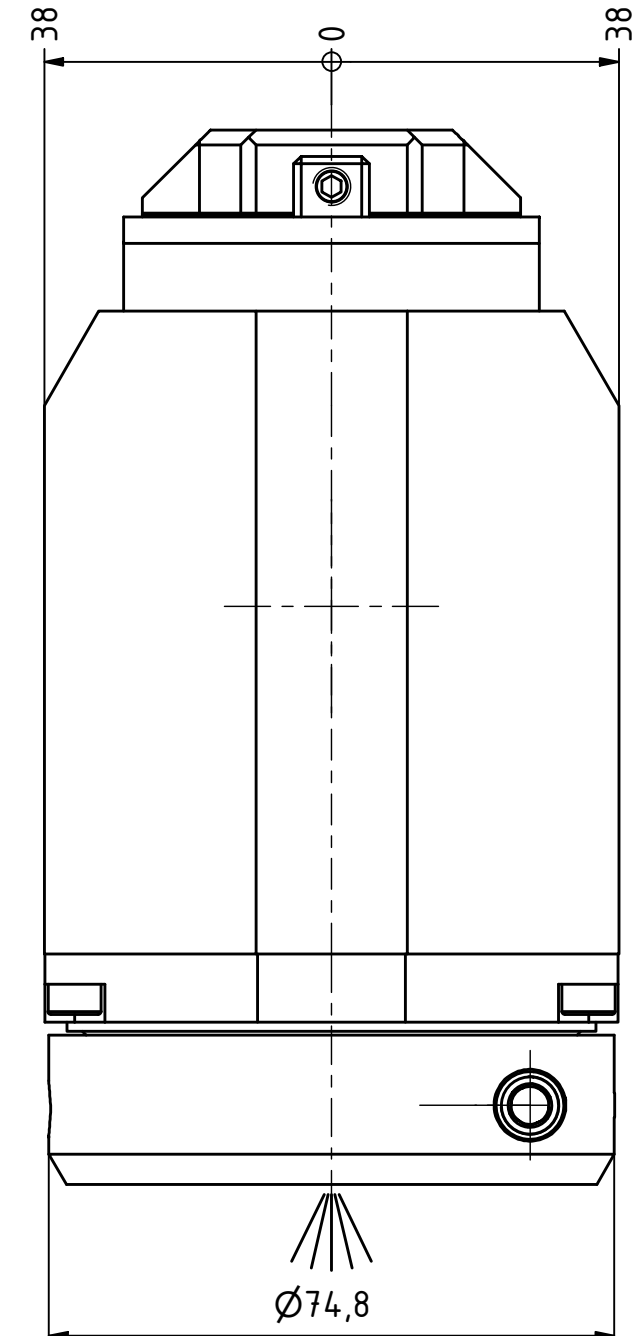
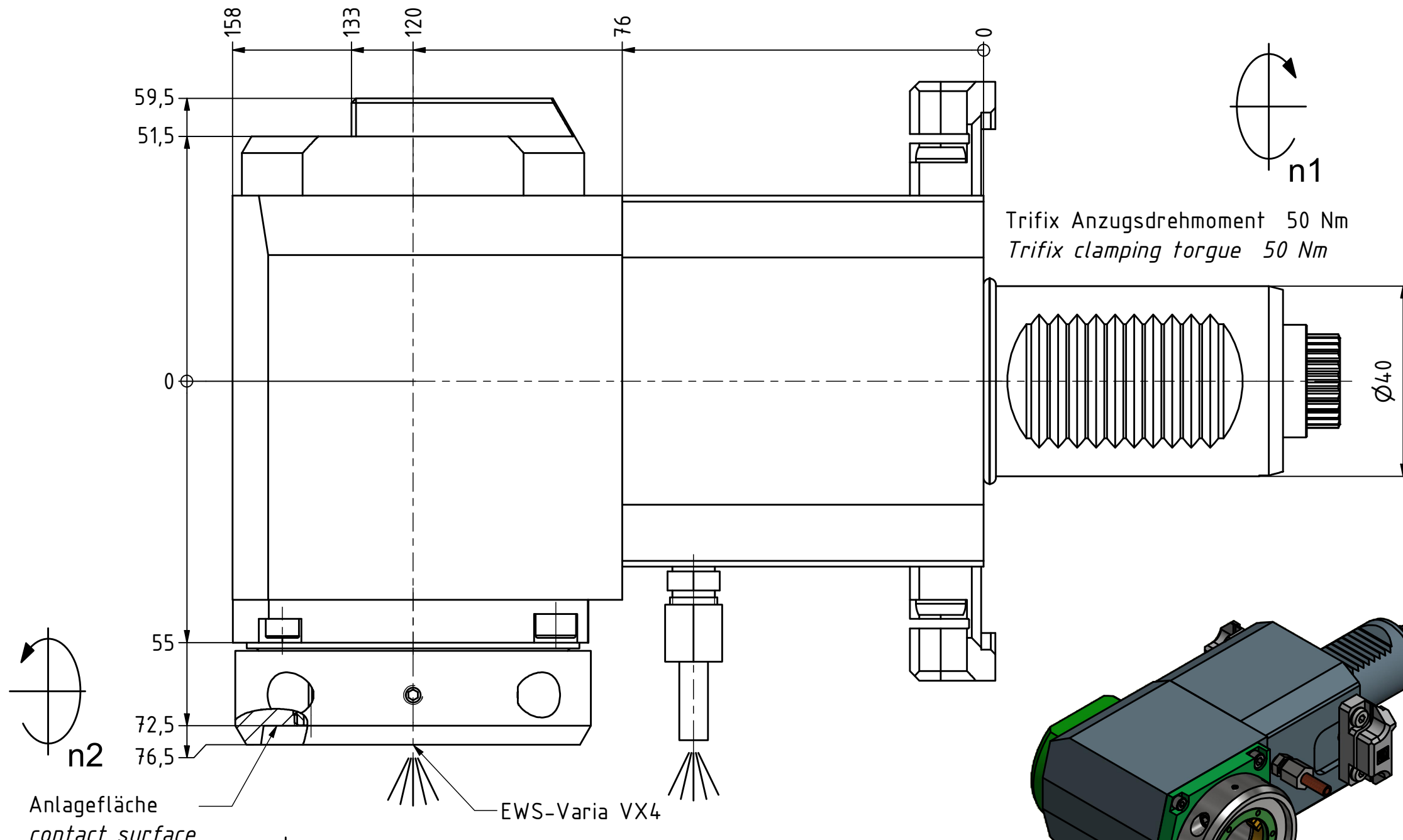

Copyright **EWS Tool Technologies**
Weitergabe und Vervielfaeltigung dieser Unterlage,
Verwertung und Mitteilung ihres Inhalts nicht
gestattet, soweit nicht ausdrecklich zugestanden.
Zuwiderhandlungen verpflichten zu Schadenersatz.

Bemerkung - Note
Für Trockenlauf geeignet!
Use without coolant fluid allowed!

Technische Daten - technical data	
Weight	= 7.649 [kg]
Torque max. (M1/M2)	= 50 / 50 [Nm]
Speed max. (n1/n2)	= 6000 / 6000 [1/min]
Gear ratio (i)=n1:n2	= 1:1
Pressure (pmax)	= 70 [bar]

Benennung - Title
Radial Bohr und Fräskopf
Radial drilling and milling head



Nr. - No.
60.40VX4LCTXRLIKDTR

Technische Aenderungen vorbehalten!
Subject to technical modifications!
IDENT: DEWS132757

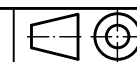

REV: -/A

MNR.
219337

