

2 zurückgesetzte Werkzeuge
 können nicht nebeneinander platziert werden!
 Einschränkung gilt nicht für C200!
 2 radial drill. and mill.head with offset
 can not be used side by side!
 Limitation does not apply to C200!

W-Verzahnung Lizenz Index-Werke
 W-tooth system licence Index-Corporation

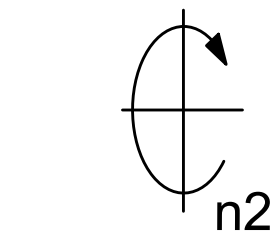
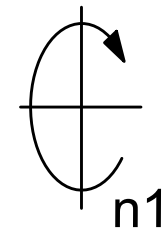
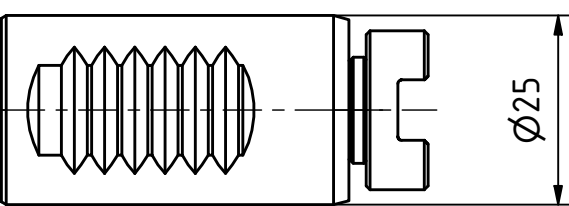

Spannzange / collet ER25 DIN6499
 Spannungsbereich / clamping range: 1,0 - 16,0

Gewindebohrzange / tapping collet
 ET-1-25 M3-M10

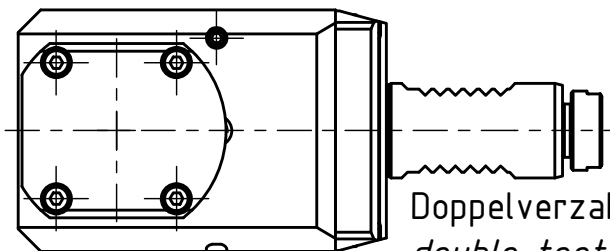
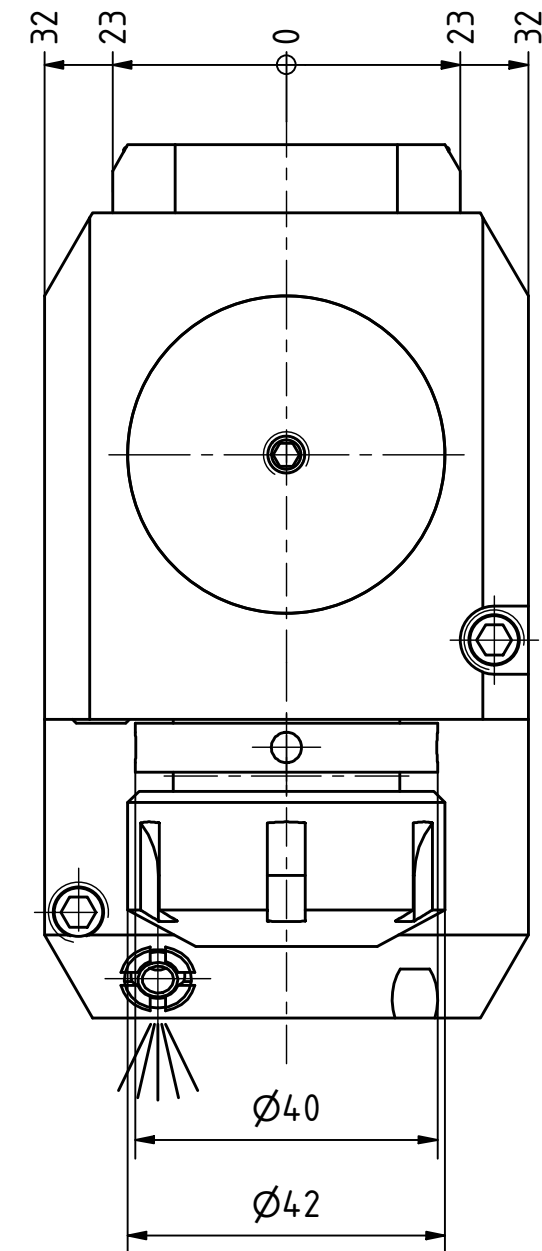

Doppelverzahnung Lizenz Traub
 double tooth system licence Traub

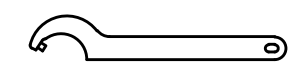
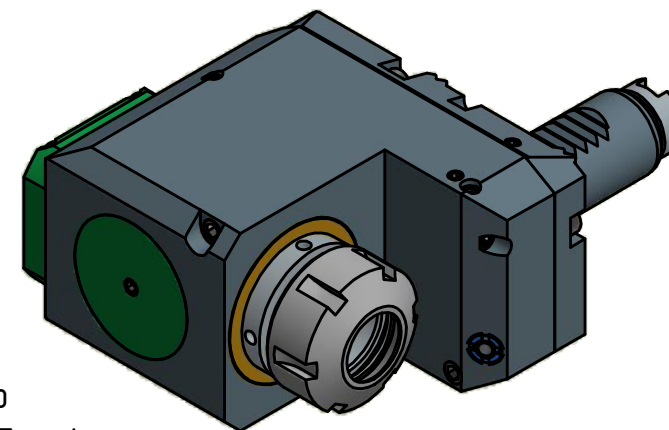

Hakenschlüssel
 mit Zapfen
 Hook wrench
 with fixed pin
 DIN1810 B 40x42

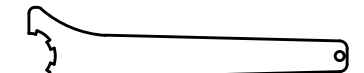

Spannzangenschlüssel
 Clamping wrench
 225

Copyright **EWS Tool Technologies**
 Weitergabe und Vervielfältigung dieser Unterlage,
 Verwertung und Mitteilung ihres Inhalts nicht
 gestattet, soweit nicht ausdrücklich zugestanden.
 Zuwiderhandlungen verpflichten zu Schadenersatz.

Bemerkung - Note

Technische Daten - technical data

Weight = 3.574 [kg]
 Torque max. (M1/M2) = 25 / 25 [Nm]
 Speed max. (n1/n2) = 8000 / 8000 [1/min]
 Gear ratio (i)=n1:n2 = 1:1

Benennung - Title

Radial Bohr und Fräskopf, zurückges
 Radial drill. and mill. head offset



Nr. - No.
 80.2525G200RLW

Technische Änderungen vorbehalten!
 Subject to technical modifications!

IDENT: D-EWS-053734



REV: -/B

MNR.

140899

