

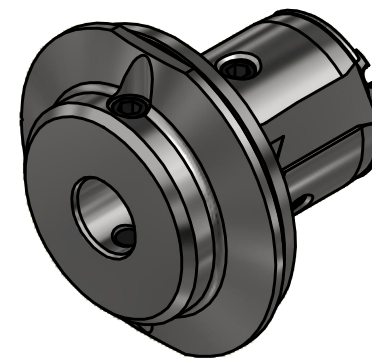

EWS.Varia

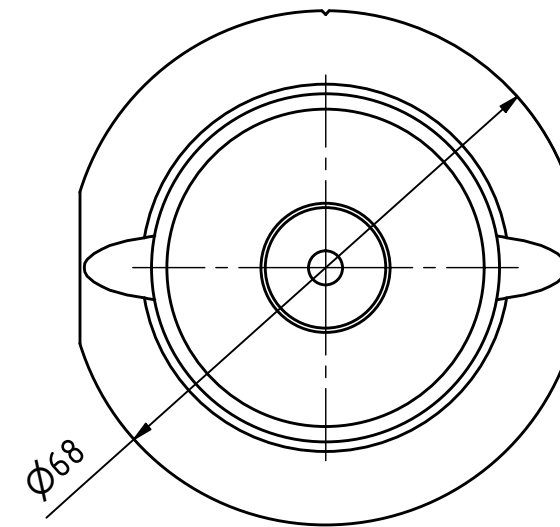

Tech  
Details

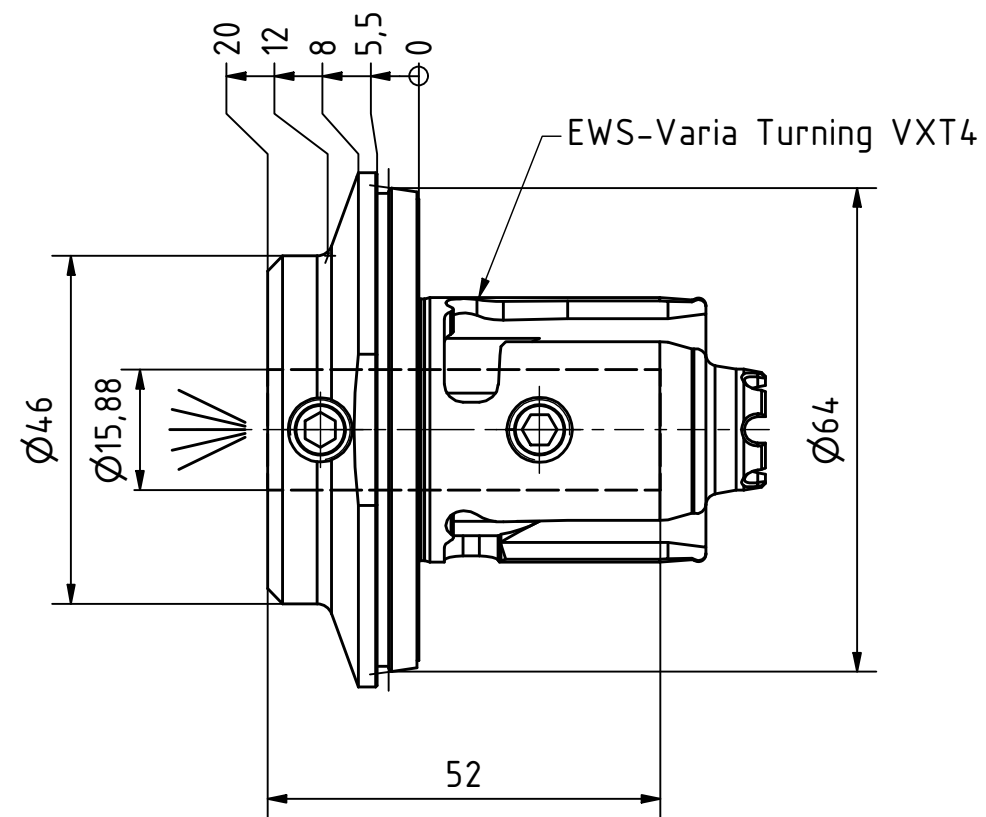

Copyright **EWS Tool Technologies**  
 Weitergabe und Vervielfaeltigung dieser Unterlage,  
 Verwertung und Mitteilung ihres Inhalts nicht  
 gestattet, soweit nicht ausdrecklich zugestanden.  
 Zuwiderhandlungen verpflichten zu Schadenersatz.

Bemerkung - Note

Technische Daten - technical data

Weight = 0.561 [kg]

Benennung - Title

**Bohrstangenhalter**  
*Boring bar holder*



EWS Weigle GmbH & Co. KG  
 Maybachstr. 1  
 D-73066 UHINGEN  
 www.ews-tools.de

Technische Aenderungen vorbehalten!  
 Subject to technical modifications!

IDENT: DEWS266653

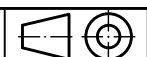

REV: -/A

Nr. - No.

19.VXT415.88L20

MNR.

232962

QR