

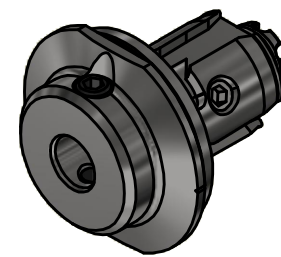

EWS.Varia

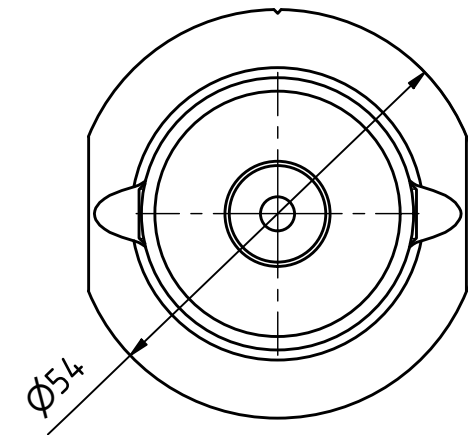

Tech
Details

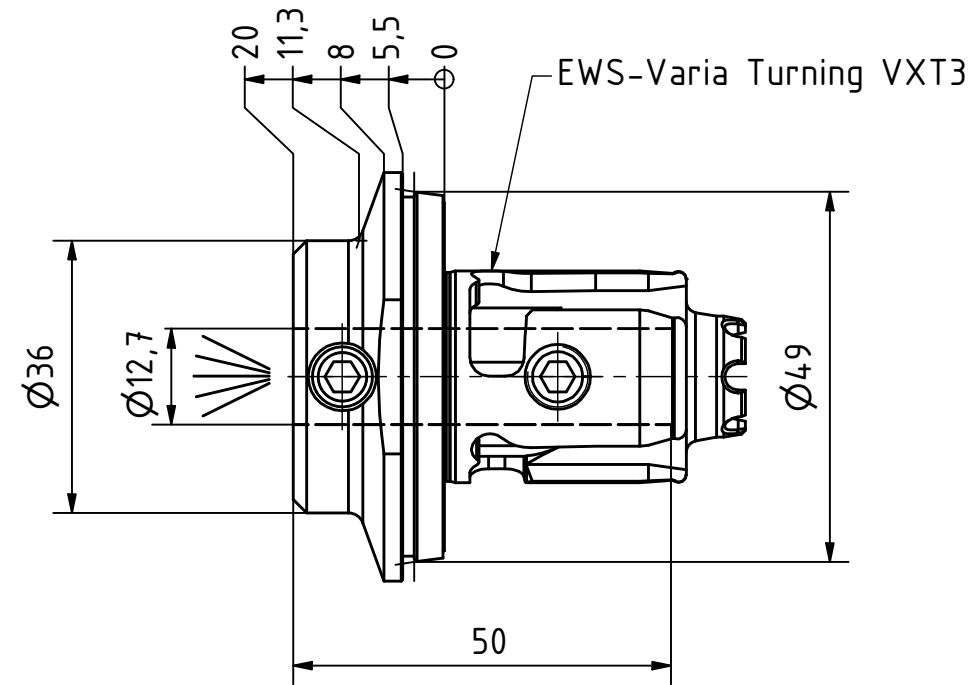

Copyright **EWS Tool Technologies**
 Weitergabe und Vervielfaeltigung dieser Unterlage,
 Verwertung und Mitteilung ihres Inhalts nicht
 gestattet, soweit nicht ausdrecklich zugestanden.
 Zuwiderhandlungen verpflichten zu Schadenersatz.

Bemerkung - Note

Technische Daten - technical data

Weight = 0.314 [kg]

Benennung - Title

Bohrstangenhalter
Boring bar holder



EWS Weigle GmbH & Co. KG
 Maybachstr. 1
 D-73066 Uhingen
 www.ews-tools.de

Technische Aenderungen vorbehalten!
 Subject to technical modifications!

IDENT: DEWS266399

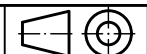

REV: -/A

Nr. - No.

19.VXT312.7L20

MNR.

232956

QR